

CALL PSE'S CUSTOMER CONSTRUCTION SERVICES AT 1-888-321-7779 OR VISIT [PSE.COM/CUSTOMERCONSTRUCTION](https://www.pse.com/customerconstruction) FOR MORE INFORMATION

PLEASE NOTE: PSE recommends the installation of gas lines at the very end of the utility construction schedule.

Builder/owner/developer responsibilities

PSE requires the following conditions to make the worksite construction ready ahead of scheduled service installation:

Permits

- Fuel line must be in place with an approved permit and plumbed to an approved gas meter location. A valid permit must be indicated by either:
 - A permit visible from outside the structure, or
 - A green **Gas Service Approval** sticker affixed to the fuel line.
- Electrical permit must be approved and the Department of Labor & Industries (L&I) sticker must be affixed on the electric meter base.

Meter location

- An acceptable meter location that allows for required access and clearance shall be provided.
 - See **Gas Meter Clearances and Service Installation Requirements (Form 3885)** for gas meter locations.
 - See **Electric Underground Service Installation Requirements (Form 6080)** for electric meter locations.

Trench work

- The worksite must be prepared to PSE specifications.
 - The site must be at final grade or have final grade marked in the area of construction and trench line route.
 - For unique site preparation requirements, contact your Project Manager.
 - Installation of trench, work pits, sand for bedding and shading, and conduit must meet PSE specifications.
 - Sand must be provided by the builder or developer and placed within hand-shoveling distance to the work pit or trench for bedding and shading. (See **Sand Requirements for Direct-Buried Installations** on page 2.)
 - If either gas or electric service will not be provided by PSE, please consult with the other utility for any additional clearance requirements. Use the greater of any conflicting distances.
 - Conduit for electric service lines shall be used under all paved surfaces, decks, rockeries, bulkheads, or obstacles to access the service line.

Additional information

- For additional electric service installation information, see **Electric Underground Service Installation Requirements (Form 6080)**.
- For additional gas service installation information and meter set assembly locations and clearances, see **Gas Meter Clearances and Service Installation Requirements (Form 3885)**.

Become familiar with what can delay your project and cause it to be red-tagged:

- Construction debris or water in the trench or work pits.
- Trenches excavated to the incorrect depth.
- Failure to maintain minimum separations between utilities and drainage pipes.
- Sand and backfill material are not available, inaccessible, or inadequate.
- Requested meter location is not acceptable or fails to meet minimum clearances.
- Permits are not approved or visible.
- Conduit color and size are incorrect, or conduit is installed improperly.



**Know what's below.
Call before you dig.**

Gas and electric underground service installation requirements

Service lines in conduit and direct-buried installations

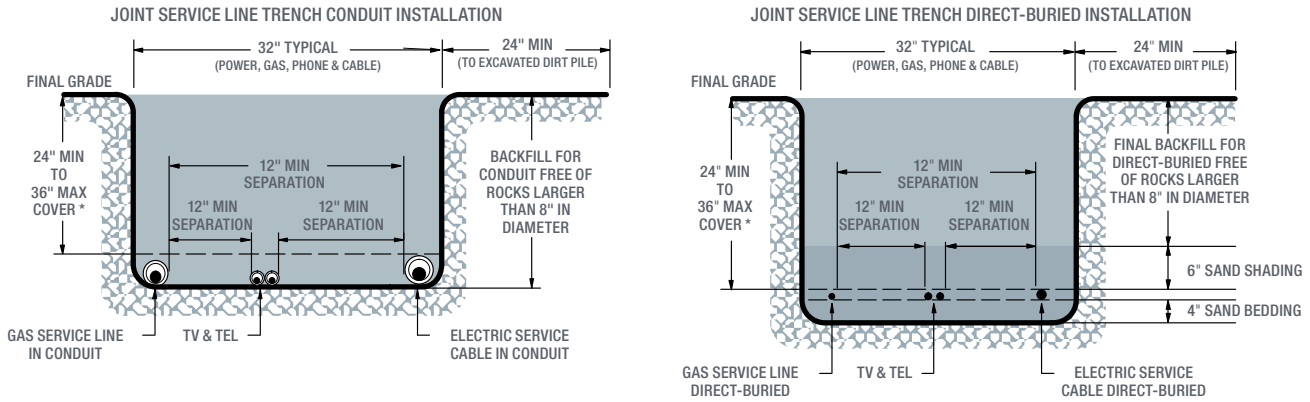

* Check with local permitting agency for depth of cover requirements for any PSE facility installed in public right-of-way.
36" cover may be required over PSE facilities.

Separation requirements to other utilities for conduit and direct-buried installations

| INSTALLATION | HORIZONTAL SEPARATION | | | VERTICAL SEPARATION WHEN CROSSING | | |
|---------------|-----------------------|---------------|--------------------|-----------------------------------|---------------|--------------------|
| | GAS TO ELECTRIC | GAS TO TV/TEL | ELECTRIC TO TV/TEL | GAS TO ELECTRIC | GAS TO TV/TEL | ELECTRIC TO TV/TEL |
| CONDUIT | 12" MINIMUM | 12" MINIMUM | 12" MINIMUM * | 6" MINIMUM | 6" MINIMUM | 12" MINIMUM * |
| DIRECT-BURIED | 12" MINIMUM | 12" MINIMUM | 12" MINIMUM * | 12" MINIMUM | 6" MINIMUM | 12" MINIMUM * |

NOTE: STACKING UTILITIES NOT PERMITTED

* Contact your TV/TEL provider about their separation requirements from power.

Backfill requirements for conduit and direct-buried installations

| INSTALLATION | BEDDING | SHADING | BACKFILL |
|---------------|--------------|--------------|---|
| CONDUIT | NOT REQUIRED | NOT REQUIRED | SOIL THAT IS FREE FROM CONSTRUCTION DEBRIS, GLASS, SHARP ROCKS, FROZEN CLOUDS, AND ROCKS LARGER THAN 8" |
| DIRECT-BURIED | 4" MINIMUM | 6" MINIMUM | |

Sand requirements for direct-buried installations

- The customer shall provide additional clean sand meeting PSE standards in piles that are readily accessible within hand-shoveling distance of each work pit for shading and bedding.
 - Sand meeting PSE specification can be found at supplier locations within the PSE service territory and is commonly referred to as "builder's sand" (ASTM C33). Call PSE's Customer Construction Services at **1-888-321-7779** for additional sand information.
 - Bedding sand will be provided and installed by the customer to a minimum depth of 4 inches prior to the electric and gas direct-buried installations.
 - Shading sand is to be installed by the PSE crew after direct-buried electric, gas, or joint service line installation. Enough sand shall be provided so that the installation can be covered to a minimum depth of 6 inches. (See diagrams above.)

Gas and electric underground service installation requirements

Property line work pit and service connections

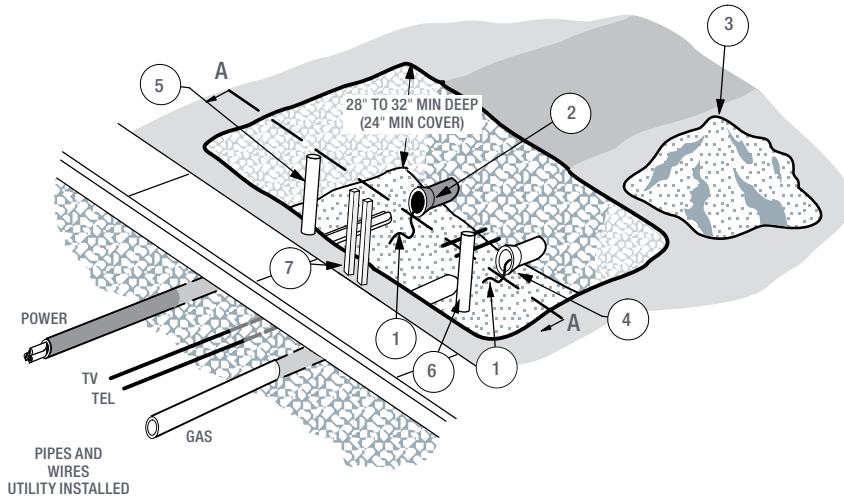

Work Pit Legend

1. 3/8" Pull Rope – 100' for gas.
2. Electric Service Conduit – Customer Provided. See **Conduit Requirements in Electric Underground Service Installation Requirements (Form 6080)**.
3. 3/4 Yard Bedding and Shading Sand – Sand shall be provided on-site by the customer and placed within hand-shoveling distance to the work pit for bedding and shading of direct-buried facilities. A larger work pit may require more sand (see sand and backfill requirements on Page 2).
4. Gas Service Conduit – Customer Provided. See **Conduit Requirements in Gas Meter Clearances and Service Installation Requirements (Form 3885)**.
5. Electric Stub Marker – Utility Provided. Power stub shall be exposed on day of service connection.
6. Gas Stub Marker – Utility Provided. Dig to expose 18" to 24" of the gas stub or the gas stub sleeve in the work pit.
7. CATV/TEL Marker

WORK PIT DIMENSIONS
ELECTRIC AND JOINT UTILITY

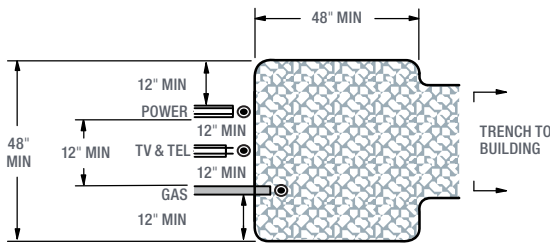

SECTION A-A
ELECTRIC AND JOINT UTILITY

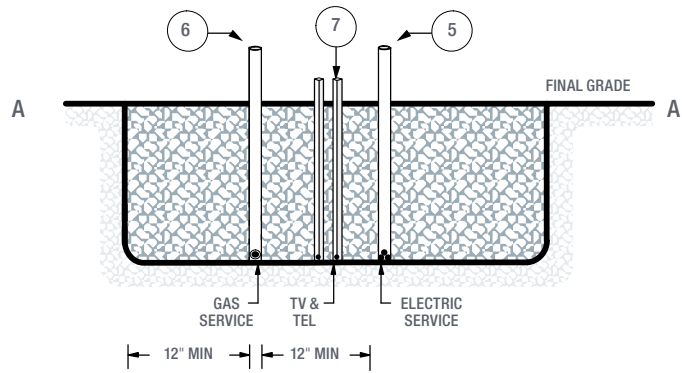

WORK PIT PROFILE AT PADMOUNTED TRANSFORMERS,
PEDESTALS OR HANDHOLES

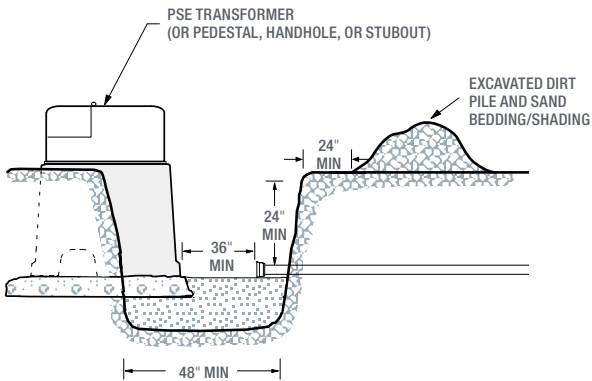

WORK PIT PROFILE AT PSE POLES

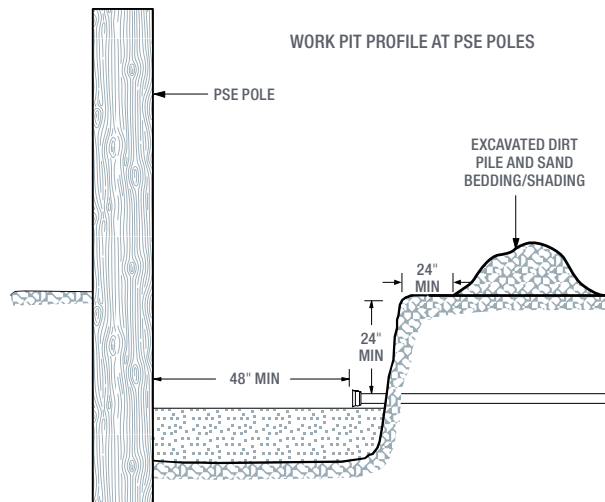

Gas and electric underground service installation requirements

Meter and service connections work pit

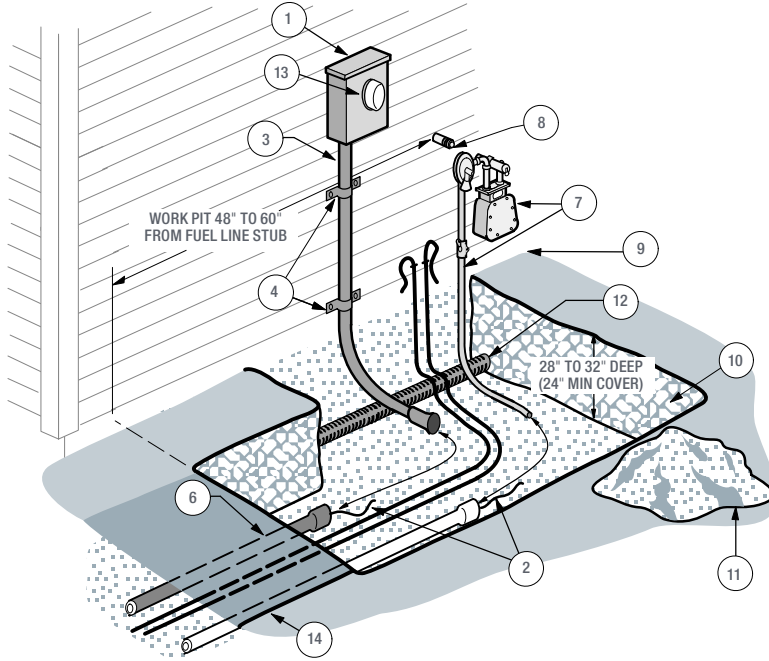

Work Pit Legend

1. **Electric Meter Base** - Customer Provided, and secured to stud or structural member.
2. **3/8" Pull Rope** - 100' for gas.
3. **Conduit Service Riser** - Customer Provided.
4. **Conduit Straps (2 Minimum)** - Customer Provided.
5. **Conduit Elbows** - Customer Provided, 24" min bend radius. See conduit requirements in [Electric Underground Service Installation Requirements \(Form 6080\)](#).
6. **Electric Service Conduit** - Customer Provided. See [Conduit Requirements in Electric Underground Service Installation Requirements \(Form 6080\)](#).
7. **Gas Meter Assembly** - Utility Provided.
8. **Fuel Line Stub Typically Protrudes 4" to 5"** - Customer Provided
9. **Finish Grade** - Finish grade shall be clearly marked at fuel line stubout.
10. **Work Pit** - Leave work pit open between gas service line conduit and proposed gas meter service riser location for gas line extension (Customer Provided).
11. **3/4 Yard Bedding and Shading Sand** - Sand shall be provided on-site by the customer and placed within hand-shoveling distance to the work pit for bedding and shading of direct-buried facilities. A larger work pit may require more sand (see sand and backfill requirements on Page 2).
12. **Drainage Pipe** - 6" minimum clearance should be maintained from gas service line.
13. **Electric Meter** - Utility Provided.
14. **Gas Service Conduit** - Customer Provided. See [Conduit Requirements in Gas Meter Clearances and Service Installation Requirements \(Form 3885\)](#).

Discontinuous and Continuous-Conduit Options

