

# Emerging resources: Resource alternatives for energy storage

Public webinar

April 23, 2024



# Welcome to the webinar!

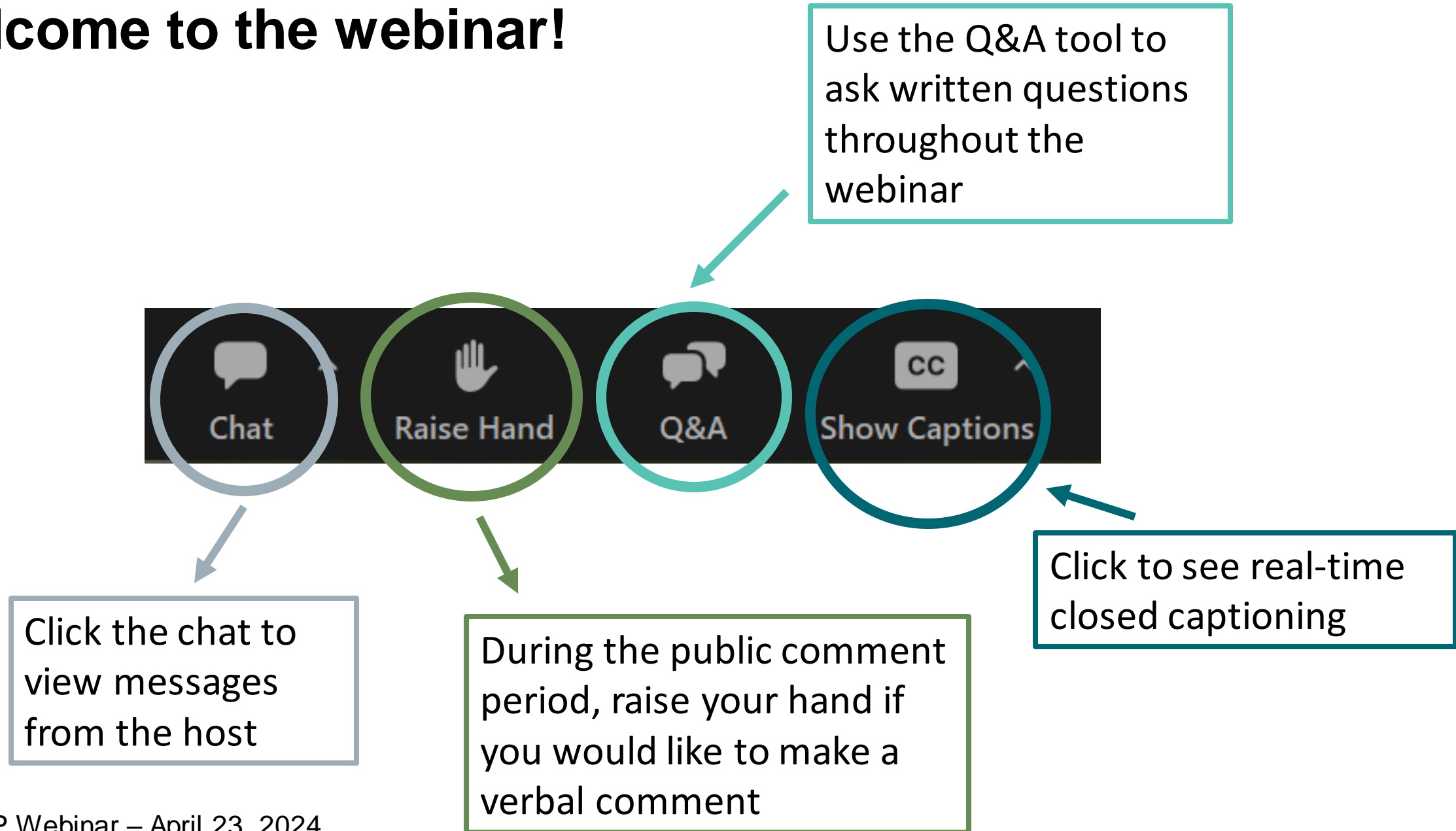

# Facilitator requests

- Engage constructively and courteously towards all participants
- Respect the role of the facilitator to guide the group process
- Avoid use of acronyms and explain technical questions
- Use the Feedback Form or email [irp@pse.com](mailto:irp@pse.com) for additional input to PSE
- Aim to focus on the webinar topic
- Public comments will occur after PSE's presentations

# Safety moment

## Outdoor hiking safety

- Research before you go (weather, trail conditions, permits etc.)
- Pack a map
- Bring extra food and water
- Keep your pet safely on a leash (if pets allowed)
- Leave wildlife and plants alone

# Today's speakers

## **Sophie Glass**

Facilitator, Triangle Associates

## **Kara Durbin**

Director, Clean Energy Strategy,  
PSE

## **Elizabeth Hossner**

Manager, Resource Planning  
and Analysis, PSE

## **Prantik Saha**

Black and Veatch

## **Michael Eddington**

Black and Veatch

## **Malcolm McCulloch**

Manager, New Products and  
Services, PSE

# Agenda

Time	Agenda Item	Presenter / Facilitator
1:00 p.m. – 1:05 p.m.	Introduction and agenda review	Sophie Glass, Triangle Associates
1:05 p.m. – 1:10 p.m.	Engagement roadmap and public feedback questions	Kara Durbin, PSE
1:10 p.m. - 1:15 p.m.	Energy storage overview	Elizabeth Hossner, PSE
1:15 p.m. – 2:05 p.m.	Energy storage technologies	Prantik Saha, Black and Veatch Michael Eddington, Black and Veatch
2:05 p.m. – 2:20 p.m.	Spotlight on Vehicle to Grid (V2G) and Vehicle to Everything (V2X)	Malcolm McCulloch, PSE
2:20 p.m. – 2:30 p.m.	Next steps and public comment opportunity	Sophie Glass, Triangle Associates
2:30 p.m.	Adjourn	All

# Engagement roadmap and public feedback questions

Kara Durbin, PSE



# IAP2 Spectrum

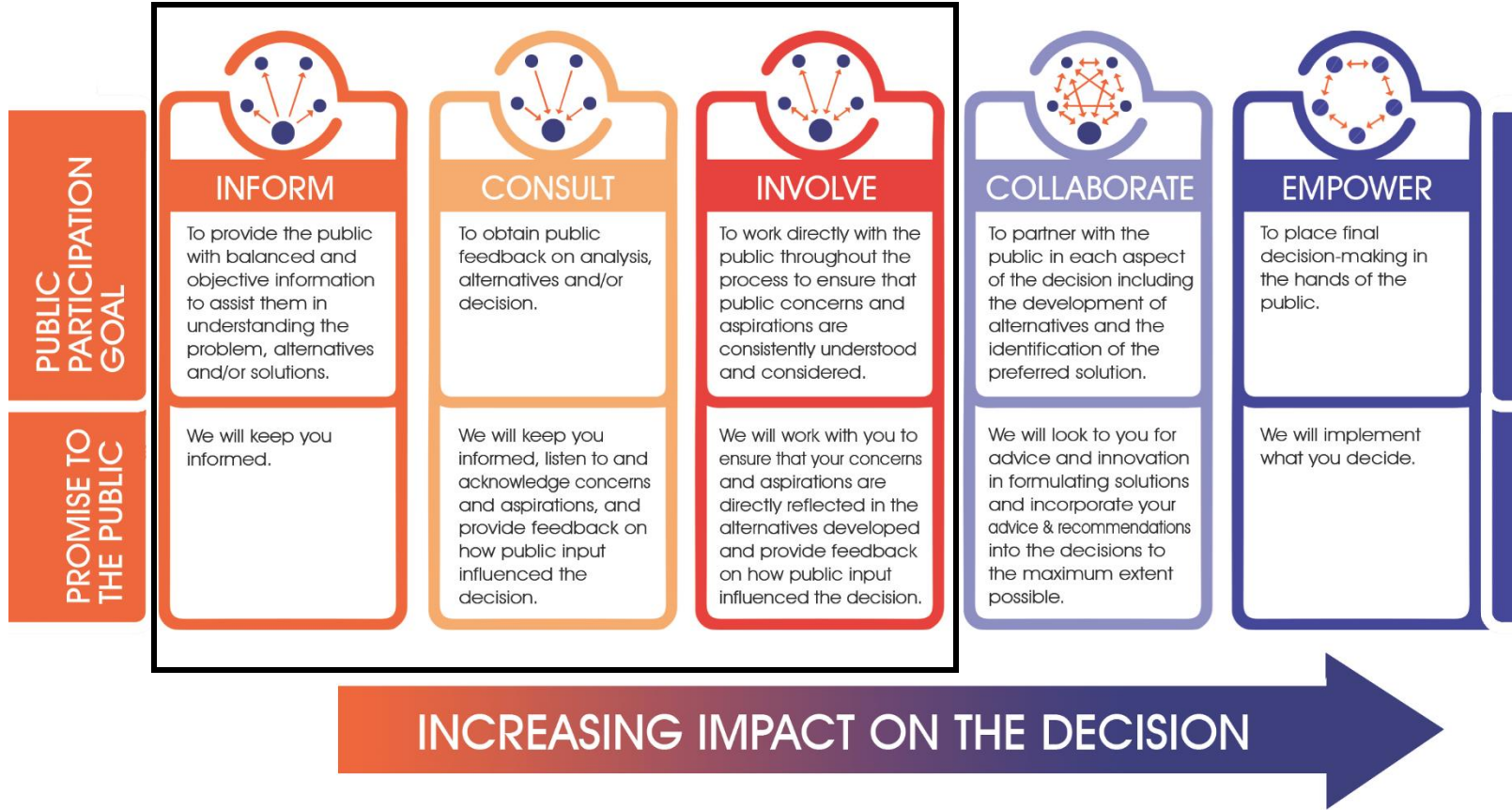



# Emerging resources engagement roadmap (“involve”)

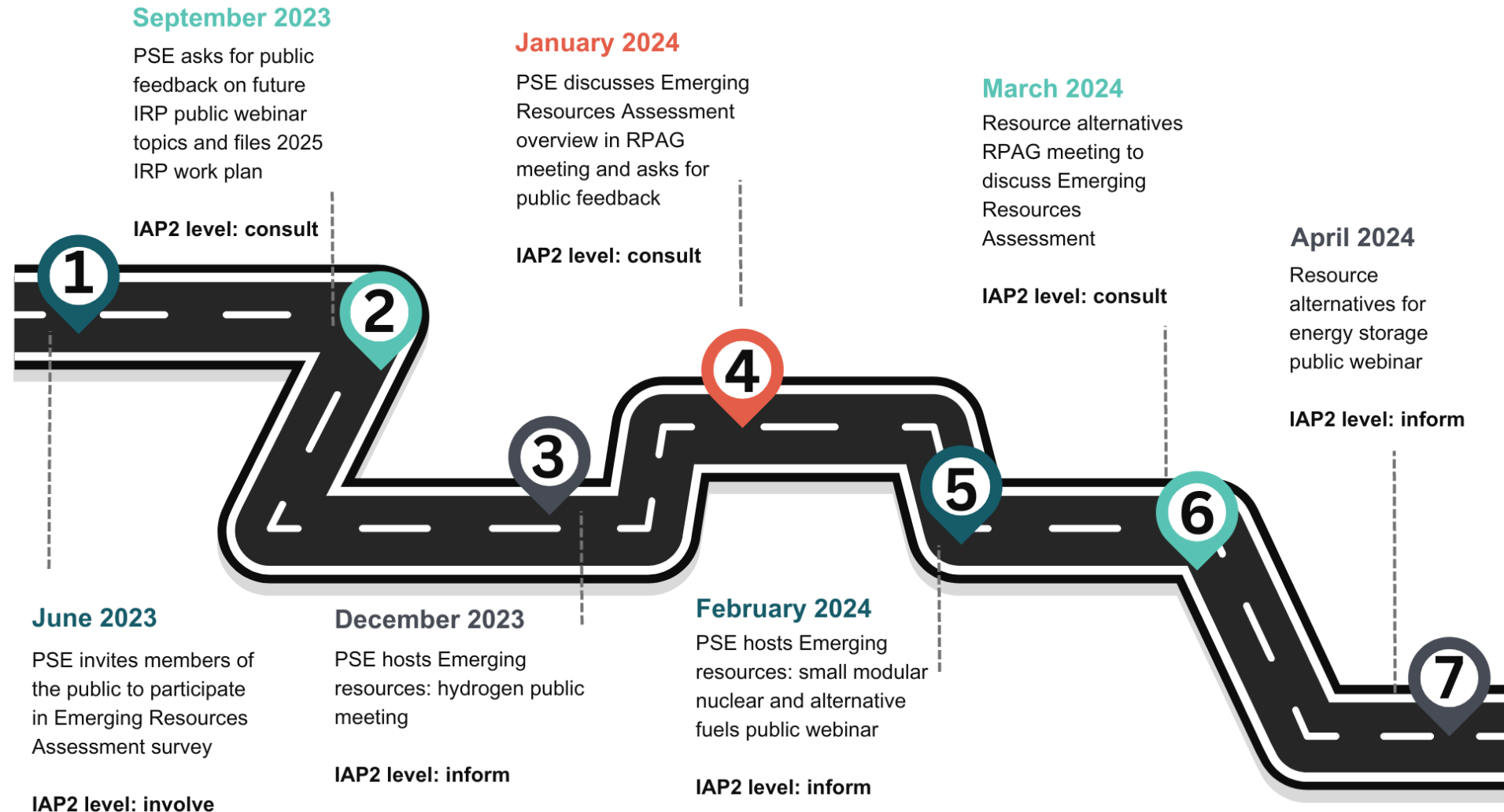

# Feedback questions

- What risks and rewards for energy storage should PSE keep in mind?
- Can you identify some examples of energy storage projects at other utilities that you think are good ones for PSE to consider?

Submit feedback via Q&A box, public comment, [Feedback Form](#), or [irp@pse.com](mailto:irp@pse.com)

# Energy storage overview

Elizabeth Hossner, PSE

April 23, 2024



# Electric resource planning

## What is the purpose of the IRP?

- Establish the resource need
- Resources identified are not a resource acquisition shopping list
- Separate acquisition and evaluation process are used to select and acquire specific resources to meet capacity and energy needs, and CETA requirements

## What is a generic resource?

- A place holder to help with evaluations, sizing, and creating a plan to meet future needs

## What is an emerging resource?

- Technology that appears likely to be viable on the timeline required in the IRP

**Today's objective:  
learn about generic  
energy storage  
options to be  
modeled (e.g.,  
batteries)**

# What is energy storage?

- Variety of technologies that allow energy to be stored for future use
  - Typically stores excess energy produced during off-peak time that would otherwise go unused
  - Storage can be called upon during peak use times and can reduce the need for other peaking capacity (e.g., natural gas peaking plant)
- Durations (how long the system can provide power) and capacities (how much energy the system can store) varies
  - Includes:
    - Various types of batteries
    - Mechanical, compressed air, and hydro systems

# Feedback on storage resources – 2023 and 2025

## 2023

- ✓ Model varying battery configurations and durations
- ✓ Model BESS
- ✓ Explore gravity storage

## 2025

- ✓ Storage technologies:
  - Model Li-ion batteries
  - Expand battery storage
  - Model established technologies for generic resources for batteries
- ✓ Explore vehicle to grid technology

# Technology Readiness Level (TRL)

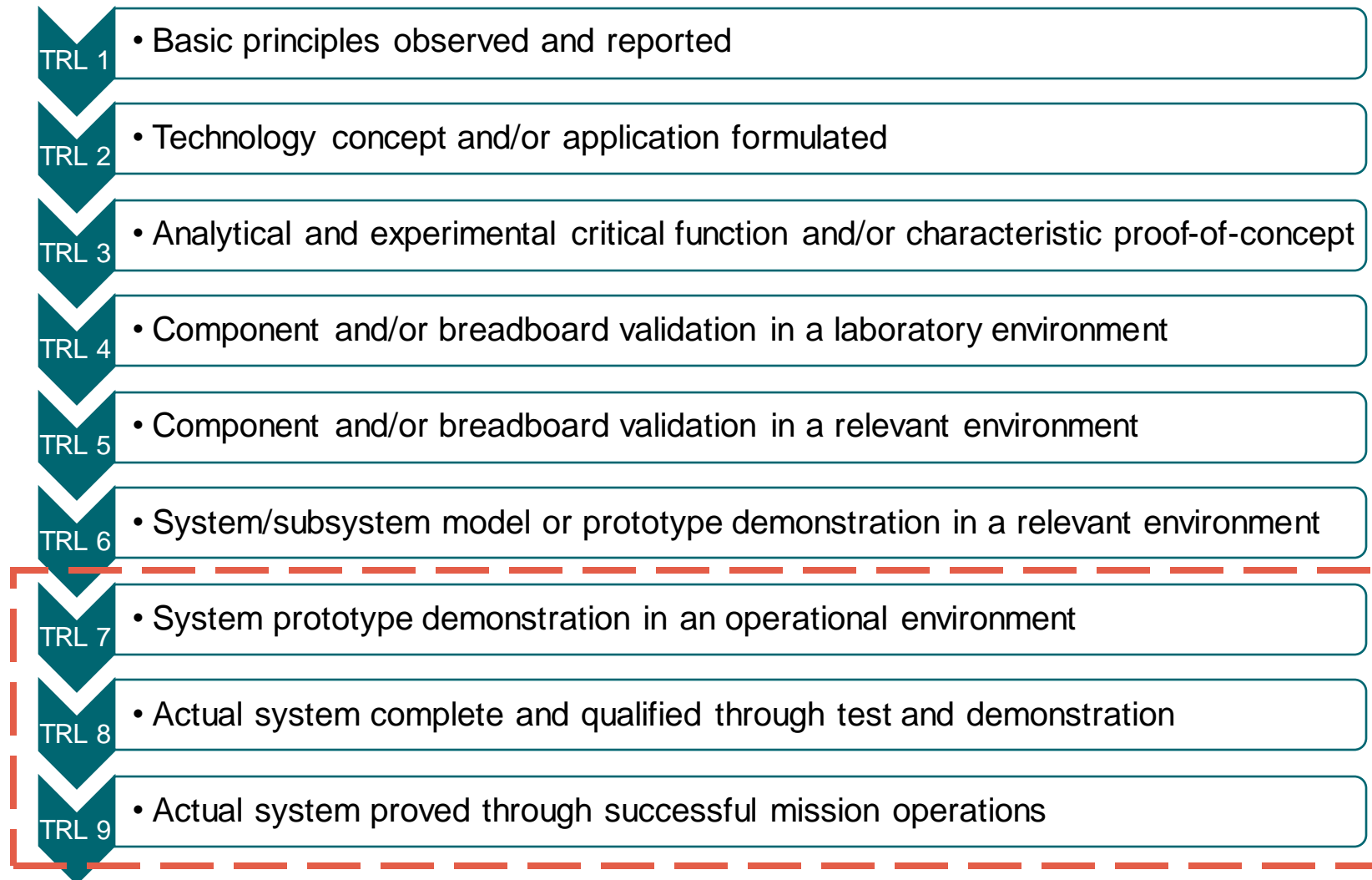

# Energy Storage Technology

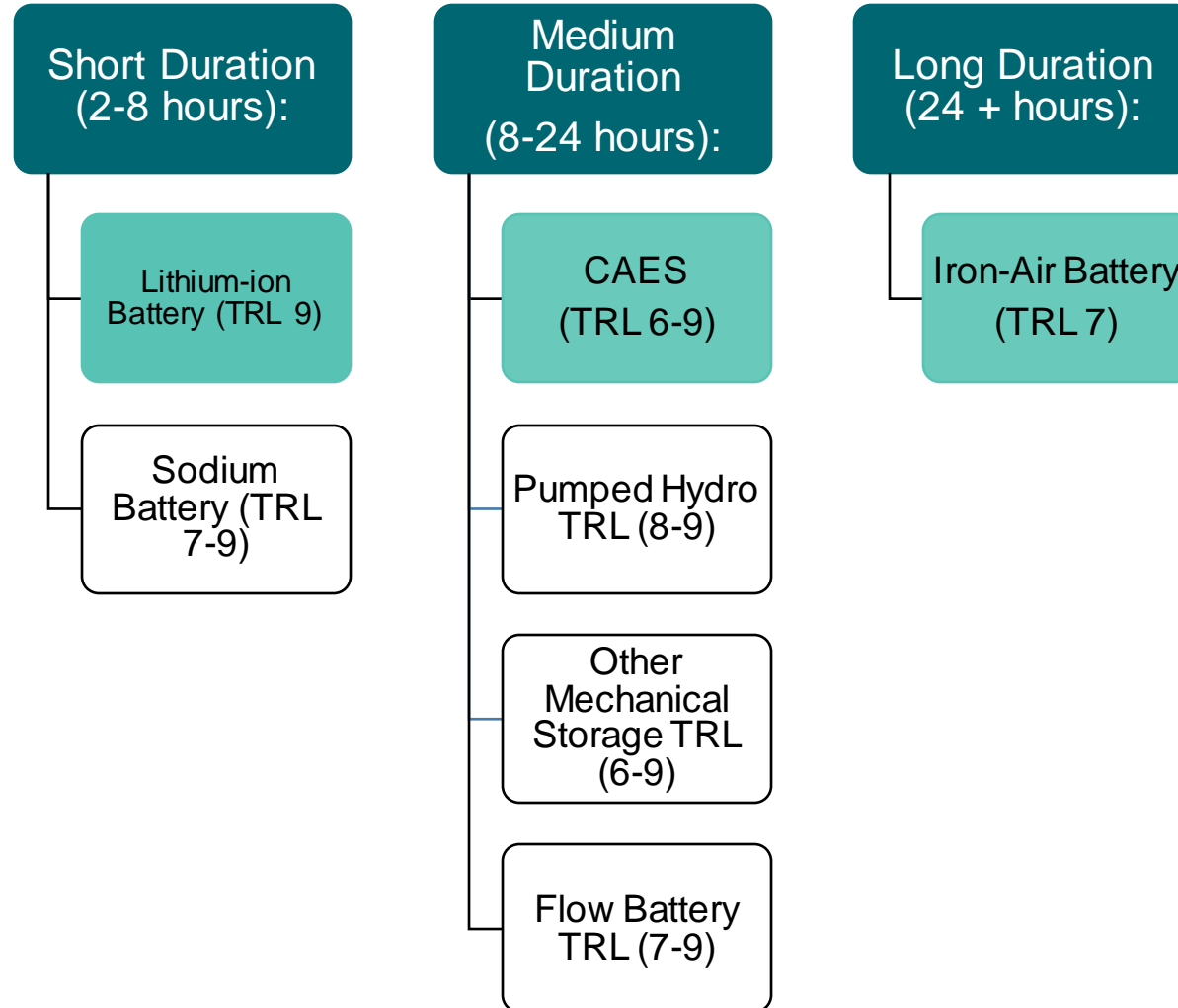



# Energy storage technology

Black and Veatch

April 23, 2024



# Short duration storage (2-8 hour): Lithium-ion and sodium-sulfur battery storage

Prantik Saha, Black & Veatch



# Short duration energy storage

## What is it?

- **2-8 hours of energy storage**
- Most deployed storage today (25+ GWh in operation globally)
- Highest technology readiness level
- Many commercial lithium-ion battery vendors available today
- High project level experience decreases project development and financing risks

## What did we study?

- Compared technical considerations and readiness for the two (2) major sub-categories
- Discussed safety concerns for both

## Sub-categories

- **Lithium-Ion Battery (4 hr)** – Lithium-nickel-manganese-cobalt oxide (NMC) and Lithium ferrous phosphate (LFP) chemistries used for energy storage
- **Sodium-sulfur Battery** – Sodium-sulfur battery uses metallic sodium and sulfur in molten state and solid-state ceramic electrolyte. Requires high temperature (> 300 C) for efficient operation.

# Battery comparison

Technology	Geological requirements	Scalability	Deployment
<b>Lithium-ion battery</b>	Flat land	<1 MW to 100+ MW exists in 1-hour to 4-hour capacities	<u>Operational</u> : The Edwards & Sanborn solar + storage facility in California 3200+ MWh <b>Li-ion BESS</b> online in 2024. It's the biggest in the US.
<b>Sodium-sulfur battery</b>	Flat land	<1 MW to 100+ MW exists in 1-hour to 4-hour capacities	<u>Operational</u> : 108 MW 6-hour <b>Sodium-Sulfur</b> project in Abu Dhabi, UAE, is operational since 2019.

# Safety concerns – lithium and metal-ion

Technology	Safety concerns
Lithium-ion battery	<ul style="list-style-type: none"><li>▪ Fire hazard due to <b>thermal runaway</b>; occurs due to external shorting or internal shorting via formation of lithium dendrite inside battery cells.<ul style="list-style-type: none"><li>○ Of the two most common chemistries, lithium-nickel-manganese-cobalt oxide (NMC) is more fire-prone than lithium ferrous phosphate (LFP) due to lower thermal runaway temperature.</li><li>○ Next generation of lithium-ion batteries are working on reducing the thermal runaway occurrence by improving design such as using liquid-cooled system and confining thermal runaway.</li></ul></li><li>▪ <b>Emission of several toxic and flammable gases</b> like hydrogen, hydrogen fluoride, ethylene, etc.</li><li>▪ <b>Electrolyte spill</b> also occurs during fire.</li></ul>
Sodium-ion battery	<ul style="list-style-type: none"><li>▪ Fire can be caused by <b>exposure</b> of highly reactive metallic sodium and sulfur at high temperature</li><li>▪ The cell container gets <b>corroded</b> fast because of the highly reactive nature of sodium and sulfur at high temperature</li><li>▪ In case of a <b>thermal runaway</b>, it may be difficult to keep the temperature from rising due to the high amount of heat released during operation</li><li>▪ <b>Molten metal</b>, if spilled, is highly reactive and can pose significant risk</li></ul>

# Medium duration storage (8-24 hour): Compressed air & mechanical energy storage

Prantik Saha & Michael Eddington, Black & Veatch

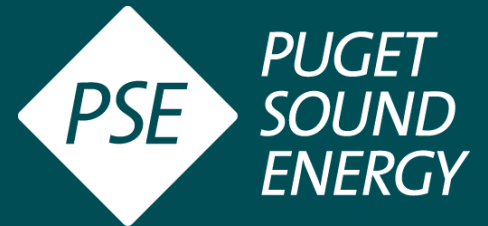

# Medium duration energy storage (MDES)

## What is it?

- **8-24 hours of energy storage**
- Grids require energy storage for up to a day when daily renewable power generation is low or zero, such as, at night.
- Used primarily for energy shifting purposes and not for grid ancillary services such as frequency regulation. Can also be used for blackstart applications depending on the response time of the storage technology.

## What did we study?

- Compared technical aspects and readiness of the sub-categories

## Sub-categories

- **Compressed air energy storage (CAES)**
- **Pumped hydro energy storage (PHES)**
- **Mechanical energy storage**
- **Flow batteries**

# Compressed air energy storage (CAES)

## What is it?

- Stores low-cost off-peak energy as compressed air or other gas
- Utilizes underground or above ground storage
- Compressed gas is released, heated, and directed into expansion turbine
- Cost-effectiveness limited by availability, design & size

## Sub-categories

- **Adiabatic** – Stores heat from compression process and upon extraction of compressed air from storage, recovers stored heat prior to expansion
- **Diabatic** – Compressed stored air heated by combusting natural gas or hydrogen using conventional combustion turbines
- **Isothermal** – Heat removed continuously from air during compression process and added continuously during expansion; no combustion process needed



# Compressed air energy storage (CAES)

Geological requirements	Technology / subcategory maturity	Scalability	Deployment
Salt caverns created by solution mining most common	TRL 9 <b>Diabatic</b>	100+ MW projects exist	<u>Operational:</u> 290 MWe project in Huntorf, Germany since 1978 110 MWe plant near McIntosh, Alabama, USA since 1991
Storage created by mining caverns into hard rock formations available in WA State	TRL 8 <b>Adiabatic / Advanced Adiabatic (AA)</b>	Sufficient demonstration to scale up to the 100 MW size or larger	<u>Operational (2017):</u> 60 MWe 5-hour Jiangsu Jintan AA-CAES Demonstration Project in China <u>In Development (by Hydrostor):</u> 500 MWe 8-hours Willow Rock Energy Storage Center in Kern County, CA, USA
None	TRL 6 <b>Isothermal</b>	Still in pilot / demonstration stage	<u>Pilot Plant (2013):</u> SustainX Inc 1.5 MWe 4-hour plant in Seabrook, New Hampshire, USA

Data derived primarily from Sandia National Laboratories, DOE Global Energy Storage Database, <https://sandia.gov/ess-ssl/gesdb/public/>, and Momentum building for Hydrostor’s Willow Rock Energy Storage Center, March 4 2024, <https://hydrostor.ca/momentum-building-for-hydrostors-willow-rock-energy-storage-center-as-company-reaches-key-permitting-and-interconnection-milestones/>

# Mechanical energy storage (MES)

## What is it?

Surplus energy on the grid is used to drive a mechanical process to store energy and then releases / converts the stored energy to electricity during peak periods

## What did we study?

Based on the expected scale and application of energy storage needed, further evaluation considered liquid air energy storage and gravitational potential energy storage

## Sub-Categories

- **Flywheels**
- **Hydraulic accumulators**
- **Liquid air energy storage (LAES)**
- **Gravitational potential energy storage**
- **Spring energy / mechanical battery storage**
- **Kinetic energy storage with rail systems**

\* Pumped hydro is MES however PSE already has adequate information, so it was not included in the study.

# Comparison of selected MES sub-categories

Technology	Geological Requirements	Technology / Subcategory Maturity	Scalability	Deployment
<b>Mechanical energy storage</b>	Specific to site and technology design criteria	<b>Liquid air energy storage (LAES)</b> TRL 8	5 MW to 200 MW+	<u>Demonstration project:</u> Commercial 5 MW 3-hours <u>Under construction:</u> Carrington 50 MW 6-hours in Manchester, UK 200 MW 12.5-hours in Yorkshire, UK
		<b>Gravity-based rail, block or piston</b> TRL 6 to 9		<u>Under construction:</u> 5 MW 15-min Advanced Rail Energy Storage (ARES) in Nevada, USA 25 MW 4-hours Energy Vault

# Liquid air energy storage (LAES) – TRL 8

## What is it?

Thermo-mechanical storage that uses electricity to liquify cool air and store in an insulated, unpressurized vessel; liquid air is then warmed to convert back to a gaseous state to operate a turbine and generate electricity.

- Can utilize waste heat for the liquefaction and expansion processes improving efficiency
- Conceptually suitable for large grid-scale storage and offers duration storage of 10 hours

## Advantages

Simplicity of the technology, scalability, flexibility, high energy density and attractive costs

## Challenges

Infrastructure requirements for storage and handling of liquid air

## Status

Near to market and currently prepared to be deployed in various locations



# Gravitational potential energy storage – TRL 6-9

## What is it?

Converts stored energy into kinetic energy to generate electricity

- ❖ Rail, block and piston-based systems are advantaged over some other types as there is little to no self-discharge of stored energy, increasing efficiency
- ❖ Broad-based application: renewable shifting, peak capacity reduction, transmission and distribution grid investment deferral, and frequency regulation

## Advantages

Potentially large grid-scale storage capacity with low environmental impact

## Challenges

Site-specific requirements, safety concerns, and need for significant elevation differences

## Status

Early-stage demonstration deployment phase, with commercial projects announced but not yet constructed

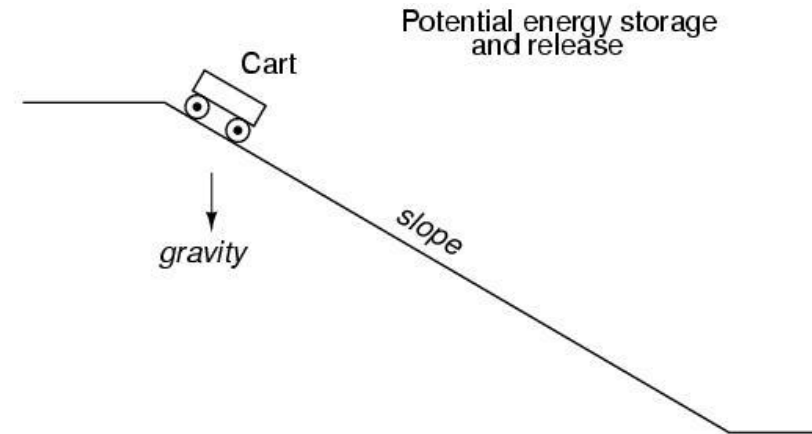

[This Photo](#) by Unknown Author is licensed under [CCBY](#)

# Flow batteries (FB)

## What is it?

- Stores energy in electrolytes using Vanadium Redox, Iron-Chloride, Zinc-Bromide or Metal Coordination electrolytes.
- Like Li-ion BESS products, they come as containerized solutions.

## What did we study?

- Compared technical aspects and readiness of the sub-categories

## Sub-categories

- **Vanadium redox**
- **Iron**
- **Zinc bromide**
- **Metal coordination complex**

# Comparison of flow battery sub-categories

Geological requirements	Technology / subcategory maturity	Scalability	Deployment
None Large footprint (vs Li-Ion)	<b>Vanadium Redox FB</b> TRL 9	Most operational projects are in 10s of MW scale. Bigger projects (100s of MW) are in construction.	<u>Operational:</u> 200 MW 4-hour project in Dalian, China. Operational since 2022. Largest operational flow battery project in the world.
	<b>Iron FB</b> TRL 8		<u>Under Construction:</u> 200 MW 10-hour project in Sacramento, CA, USA
	<b>Zinc-Bromide FB</b> TRL 7	Pilot projects at 2 to 10 MW scale underway	<u>Under Construction:</u> 2 MW 10-hour project in CA, USA
	<b>Metal-Coordination Complex FB</b> TRL 7		<u>Pilot Project:</u> 5 MW 8-hour project in Alberta, Canada

The difference primarily comes from the electrolytes used, e.g., vanadium-based electrolytes for vanadium FBs, iron-chloride for iron FBs etc.

# Safety concerns – sodium-ion and flow

Technology	Safety concerns
<b>Sodium-ion battery</b>	<ul style="list-style-type: none"><li>▪ Fire hazard due to <b>thermal runaway</b> can occur<ul style="list-style-type: none"><li>○ High operating temperature increases risk of thermal runaway; low reactivity of sodium compared to lithium makes the overall risk much lower</li></ul></li><li>▪ Ceramic electrolyte is a solid-state ion conductor; <b>no</b> chemical spill or gas emission risk</li><li>▪ <b>Molten metal</b> can be a potential source of risk.</li></ul>
<b>Flow battery</b>	<ul style="list-style-type: none"><li>▪ Do not have any significant fire hazard like lithium-ion batteries</li><li>▪ <b>Vanadium oxide</b> used in vanadium flow batteries is highly acidic; it is <b>very corrosive</b> if spill occurs</li><li>▪ Iron flow battery uses iron chloride as the electrolyte which is safer than vanadium oxide</li><li>▪ <b>Bromine-based electrolytes</b> that are used in zinc-bromide batteries are <b>very corrosive</b></li></ul>



# Long duration energy storage (LDES; 24-100 hour): metal-air and flow battery storage

Prantik Saha, Black & Veatch



# Long duration energy storage (LDES)

## What is it?

- **24+ hours of energy storage**
- Days long energy storage systems can perform various functions
- Grids require days-long energy storage for resilience, when the daily renewable power production profile is not consistent. Wind power farms in US Midwest tend to have this daily inconsistency.
- Can perform as a backup power supply too.

## What did we study?

- Technical considerations and readiness for the one major sub-category

## Sub-categories

- **Iron (Fe)-Air Batteries** – These batteries are strong contenders of 24+ hour storage durations

# Characteristics for iron-air battery

Technology	Geological requirements	Technology / subcategory maturity	Scalability	Deployment
Iron-air battery	None Large footprint (vs Li-Ion)	TRL 7	Up to 10 MW most common currently	<u>Under Construction</u> : 10 MW 10-hour <b>Iron-Air</b> battery pilot projects in Colorado and Minnesota, USA

# Safety concerns for iron-air battery

Technology	Safety concerns
Iron-air battery	<ul style="list-style-type: none"><li>▪ Metal-air batteries do <u>not</u> pose any significant safety or fire hazards</li><li>▪ An alkaline <b>electrolyte</b> is used which is <b>mildly corrosive</b></li><li>▪ Ceramic electrolyte is a solid-state ion conductor with <b>no</b> chemical spill or gas emission risk</li></ul>

# Spotlight on V2G and V2X

Malcolm McCulloch, PSE

April 23, 2024

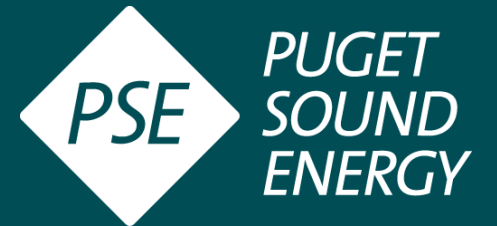

# Vehicle-to-everything (V2X) overview

## Opportunity

Customer adoption of **EVs** is **growing rapidly** which promotes **two-way flows of energy** and offer opportunities for utilities and customers to **work together** and innovate to meet rising demand.

## Desired Outcome

Identify and evaluate the technical feasibility, operational requirements, and interconnection protocols, as well as to engage with customers and interested parties to assess the benefits, barriers, and market readiness for V2X.



### Customer benefits

- Back-up power during outages
- Compensation for PSE's use of EV battery capacity
- Possible demand charge reduction

### System benefits

- Capacity resources
- Load balancing & grid stability
- Distribution equipment upgrade deferral

# V2X configurations

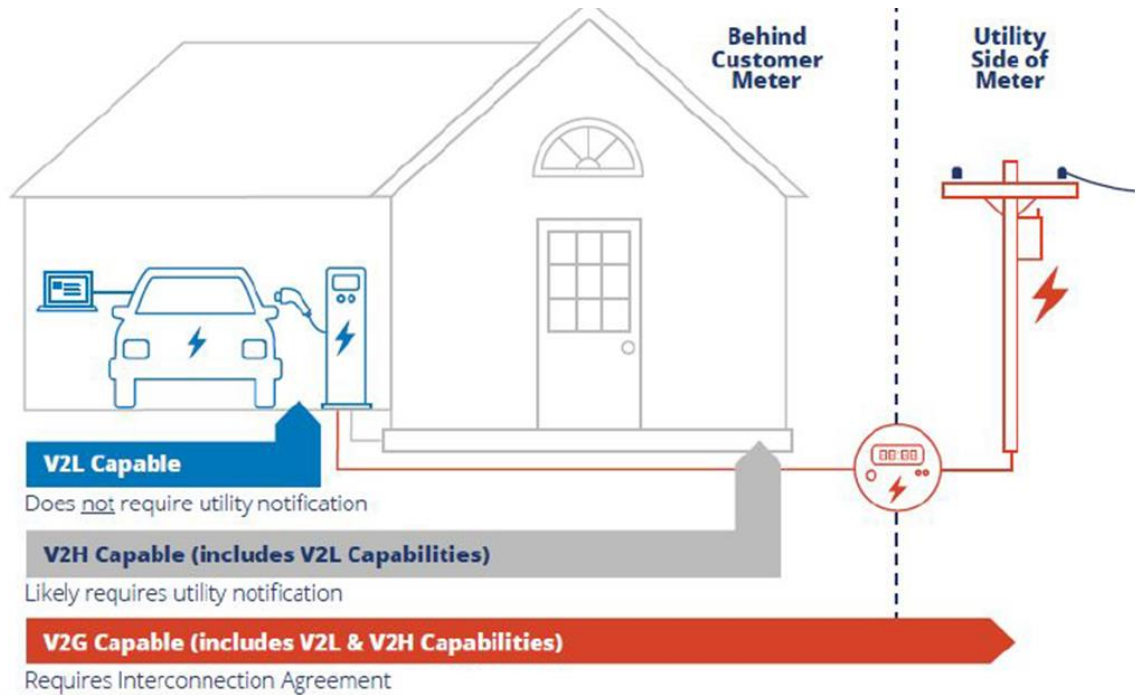

Source: SEPA. (2023).

## Definitions

**Vehicle-to-Home/Building (V2H/V2B):** involves using an EV to provide supplementary power to a building.

**Vehicle-to-Grid (V2G):** actively injecting electricity back into the grid and requiring utility approval in the form of interconnection agreements.

# V2X market readiness

- Limited availability of bidirectional vehicles and chargers
- Implementation complexity due to lack of standardization and interoperability across market actors
- Customer willingness to adopt unclear, but new V1G programs (EV/EVSE direct load control) may serve as proxy to induce scale
- Higher incremental costs for equipment and interconnection increases barrier to entry

Figure 2. Stages of Mass-Market Customer Adoption of Different V2X Use Cases

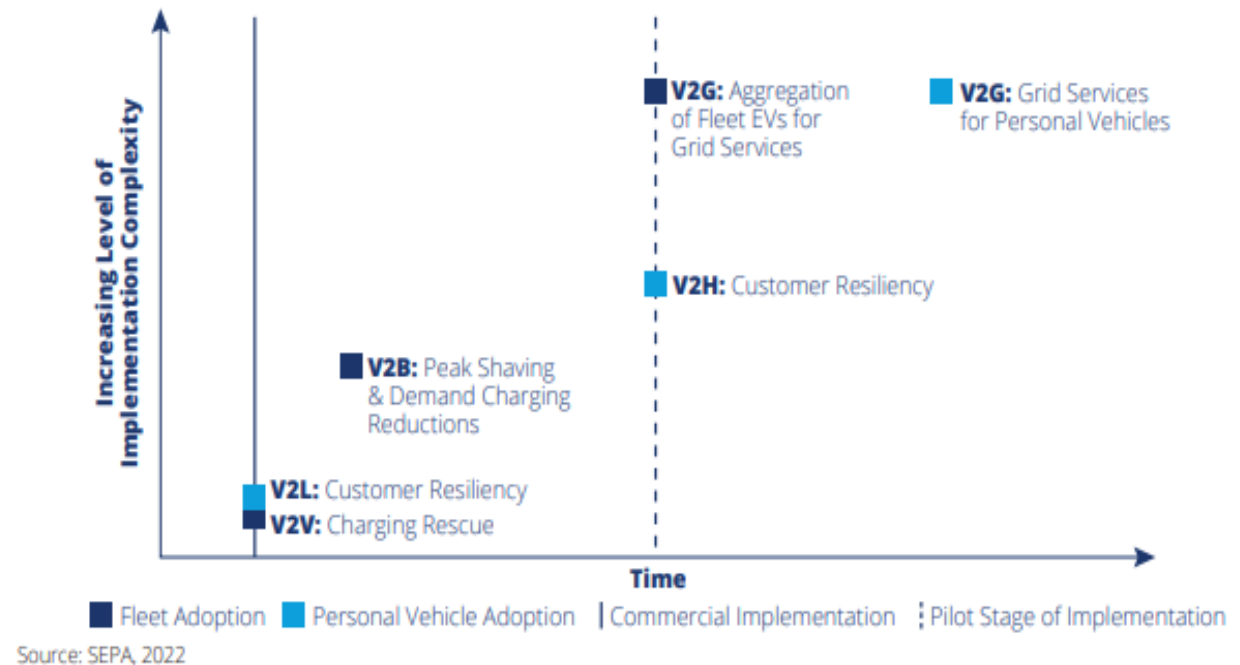



# V2X technology demonstration strategy

## Vehicle-to-Home (V2H)

- **Scope:** Up to 10 installations with bi-directional EVs.
- **Outcomes:** Establish technical requirements, qualified equipment lists, integration with VPP, demand reduction potential, customer preferences, and interaction w/ EV DR, Residential BESS, and TOU programs

## Vehicle-to-Building (V2B)

- **Scope:** Up to 4 bi-directional fleet vehicles stationed with mix of L2 & DCFC at fleet facilities.
- **Outcomes:** Establish technical requirements, qualified equipment lists, integration with VPP, demand reduction potential, customer preferences, and interaction w/ demand charge rates, Business DR, and Commercial BESS programs

## Vehicle-to-Grid (V2G)

- **Scope:** Up to 2 electric School District customers (4 electric buses combined) with existing bi-directional capable medium/heavy duty electric school bus & ability to install bidirectional high capacity L2 or DCFC EVSE.
- **Outcomes:** Establish technical requirements, qualified equipment lists, integration with VPP, interconnection standards, demand reduction potential, dispatchable capacity potential, customer preferences, future compensation models, and interaction w/ demand charge rates, Business DR, and Commercial BESS programs

# V2X technology demonstration roadmap



## Next Steps

- Conduct market and customer research
- Define equipment protocols and interconnection standards
- Develop VPP and related technology partnerships
- Initiate customer journey & product development process
- Facilitate interested party engagement
- Establish feasibility and equity scoring to refine product concepts
- Identify potential demonstration sites & conduct enrollment
- Dispatch V2H/V2B/V2G sites during peak event

# Next steps

Sophie Glass, Triangle Associates



# Additional resources

- December 7, 2023 Emerging Resources: Hydrogen public webinar [recording](#) and [presentation](#)
- January 12, 2024 Emerging Technology Assessment overview RPAG meeting [recording](#) and [presentation](#)
- February 27, 2024 Emerging Resources: Small Modular Nuclear and Alternative fuels public webinar [recording](#) and [presentation](#)
- March 25, 2024 Emerging Technology Assessment and Resource Alternatives RPAG meeting [recording](#) and [presentation](#)

# Upcoming activities

Date	Activity
April 30, 2024	<a href="#">Feedback form</a> closes for this webinar
May 9, 2024	Local and regional delivery infrastructure needs public webinar
May 14, 2024	Western Resource Adequacy Program (WRAP) overview RPAG meeting



Email us at [irp@pse.com](mailto:irp@pse.com)



Visit our website at [pse.com/irp](https://pse.com/irp)



[Register for email updates](#)



Leave a voice message at 425-818-2051

# Public comment opportunity

Please raise your “hand” if you would like to provide comment.



**Thanks for joining us!**



# Appendix

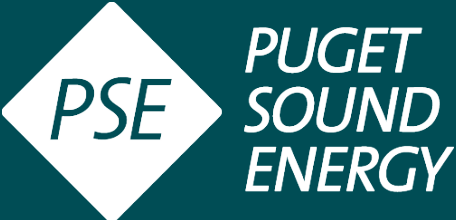



# Acronyms

Acronym	Meaning
AA	Advanced adiabatic
ARES	Advanced rail energy storage
BESS	Battery energy storage system
CAES	Compressed air energy storage
CCA	Climate Commitment Act
CEIP	Clean Energy Implementation Plan
CETA	Clean Energy Transformation Act
IAP2	International Association of Public Participation
IRA	Inflation Reduction Act
IRP	Integrated Resource Plan
kW	Kilowatt
kWh	Kilowatt hour
LCOE	Levelized cost of energy
LDES	Long duration energy storage
Li	Lithium ion
LFP	Lithium ferrous phosphate

# Acronyms

Acronym	Meaning
MES	Mechanical energy storage
MW	Megawatt
Mwe	Megawatt electric
MWh	Megawatt hour
NMC	Nickel-manganese-cobalt oxide
NRELATB	National Renewable Energy Laboratory Annual Technology Baseline
O&M	Operations and maintenance
PHES	Pumped hydroelectric storage
RA	Resource adequacy
RPAG	Resource Planning Advisory Group
TIC	Total installed cost
TRL	Technology readiness level
V2G	Vehicle-to-grid
V2X	Vehicle-to-everything

# Lithium Ion Battery



Source: PG&E; Moss Landing Battery Energy Storage

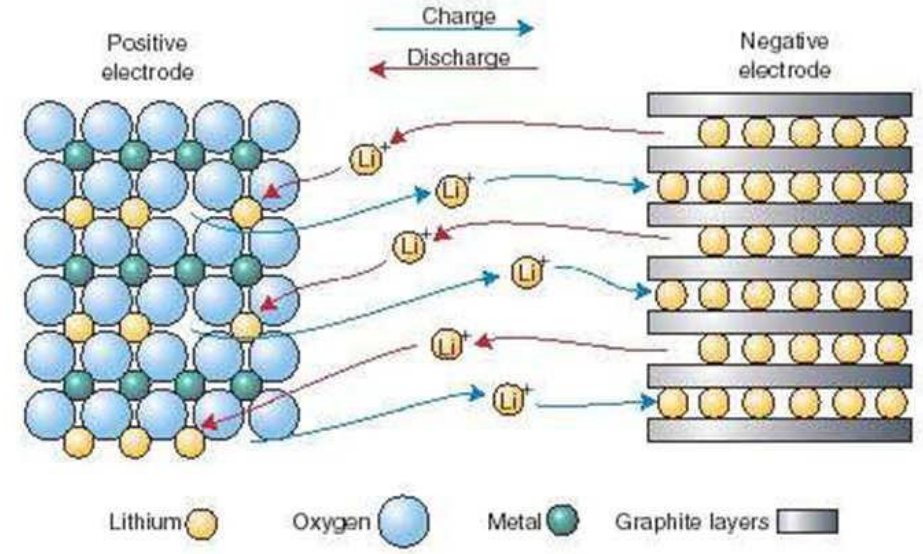

Source: LFP batteries; <https://www.lythbattery.com/lifepo4-battery-vs-lead-acid-battery/>

# Sodium sulfur battery

Short  
Duration

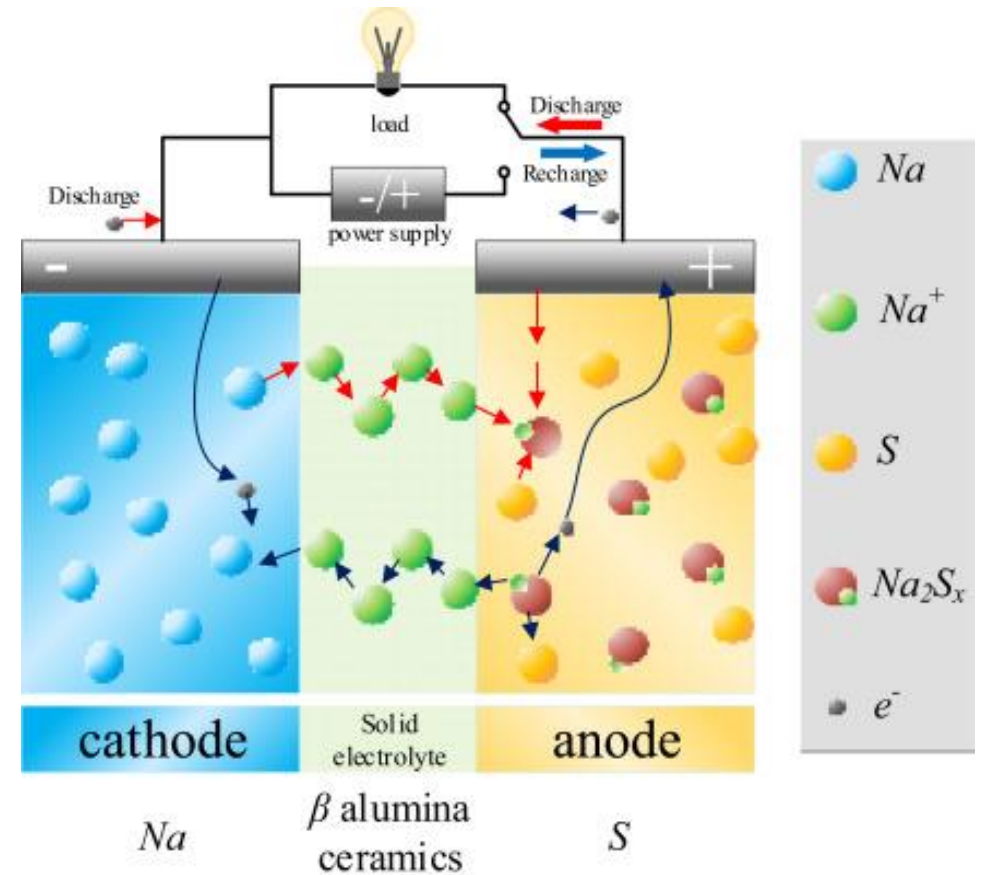

10-hour advanced adiabatic - CAES selected for further characterization

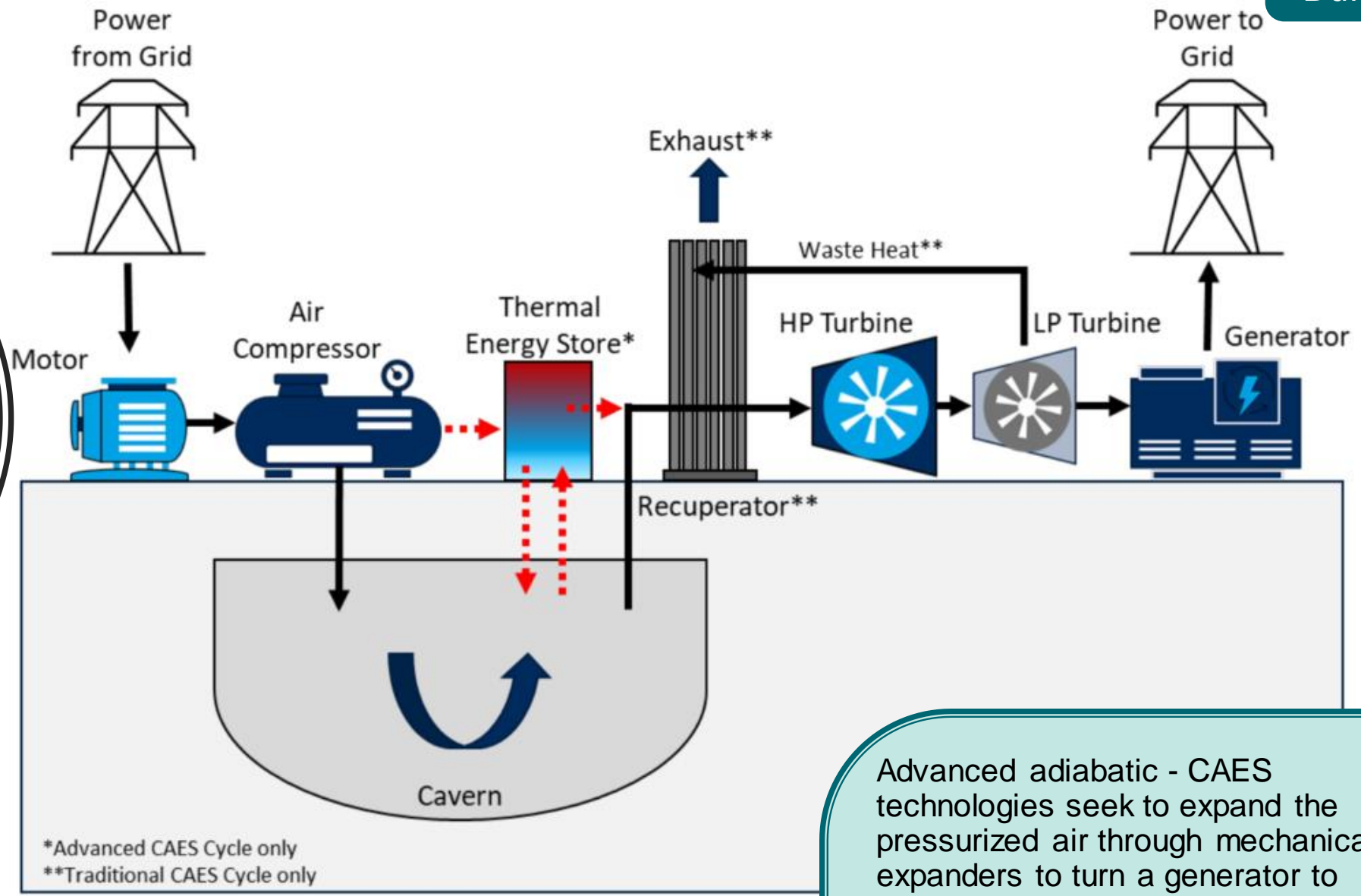

\*Advanced CAES Cycle only  
\*\*Traditional CAES Cycle only

Advanced adiabatic - CAES technologies seek to expand the pressurized air through mechanical expanders to turn a generator to provide carbon-free electricity

# VANADIUM REDOX FLOW BATTERY

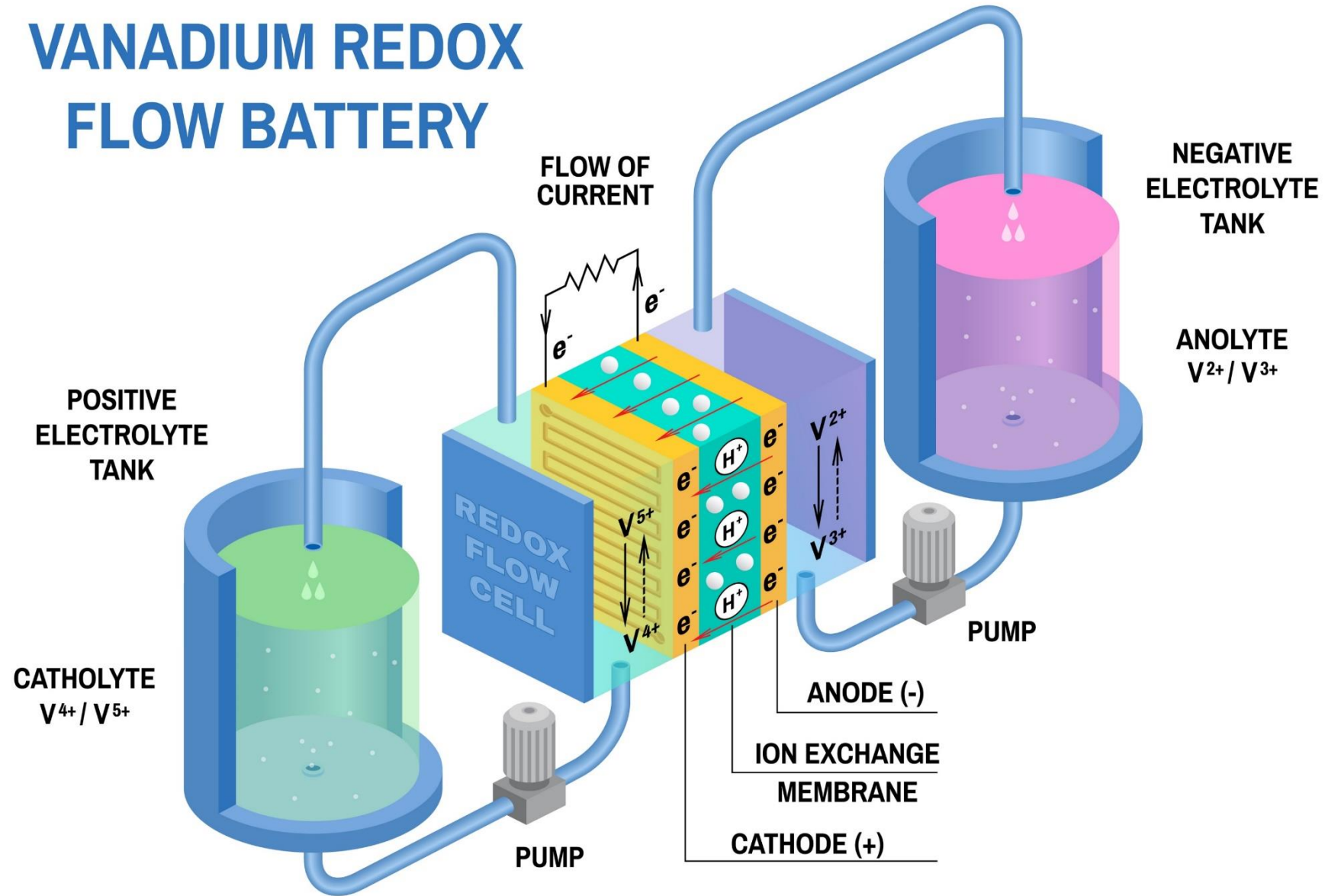

# Form Energy's Iron-Air Battery

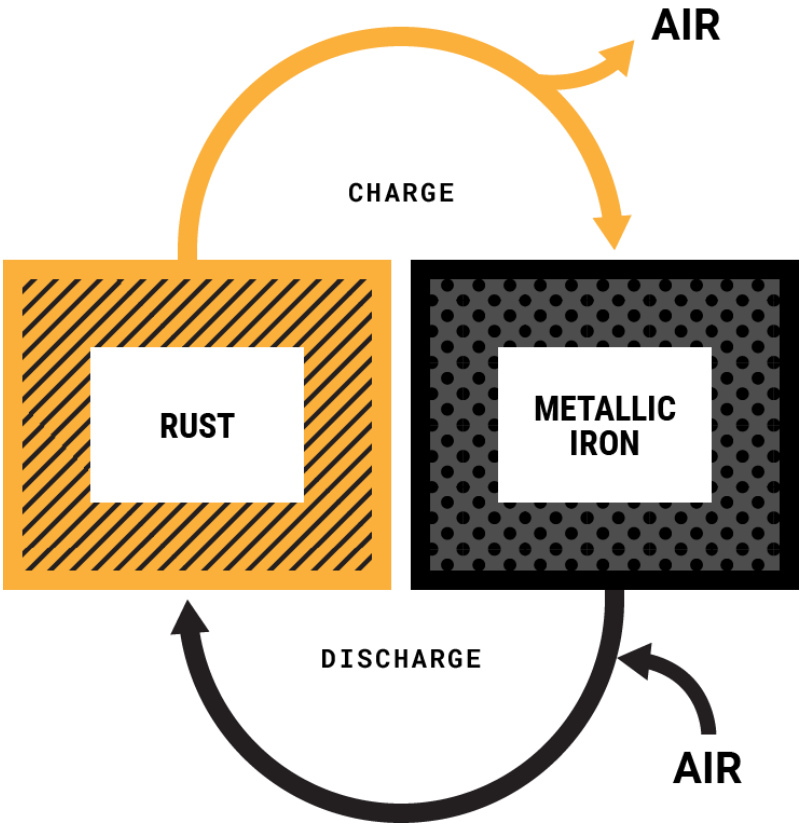

The iron-air battery cycle. Image courtesy of Form Energy.

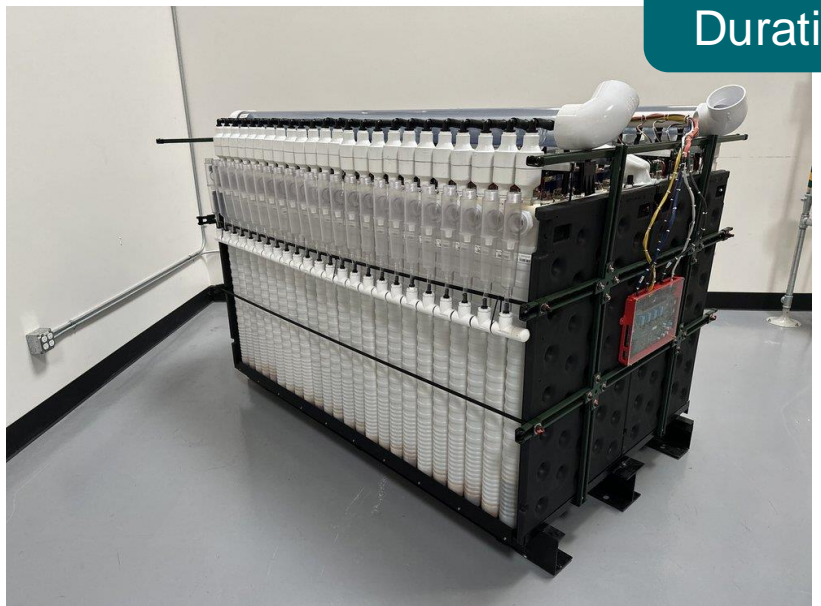

Form Energy's 2023 iron-air battery module prototype. Image courtesy of Form Energy



An artist rendering of a 56 megawatt energy storage system, with iron-air battery enclosures arranged next to a solar farm. Image courtesy of Form Energy.

# Supply-side resource alternatives for the 2025 IRP

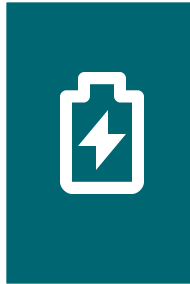

## Energy Storage

- Short duration (Lithium-Ion 4 hour)
- **Medium duration (CAES 8-hour) - Emerging**
- **Long duration (Iron-Air 100-hour) - Emerging**



## Wind

- Onshore wind
- **Offshore wind - Emerging**
- Hybrid and co-located with energy storage and solar



## Solar Photovoltaic (PV)

- Utility scale
- Hybrid and co-located with energy storage and wind



## Non-Emitting Baseload

- **Small Modular Reactor (SMR) - Emerging**



## Combustion Turbine (peaker)

- Natural Gas with R99 backup
- **Hydrogen/NG blend with R99 backup - Emerging**
- R99

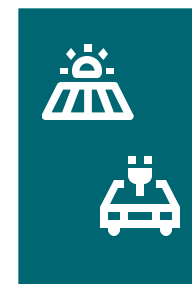

## Distributed Energy Resources

- Solar
- Energy storage



# Storage technology comparisons

Technology		Advantages	Disadvantages	TRL	Previously Modeled
Short Duration (2-8 hrs)	Lithium-ion	<ul style="list-style-type: none"> <li>Most readily available today</li> <li>Reliable with long lifespan and little to no maintenance required</li> <li>High power and energy density</li> </ul>	<ul style="list-style-type: none"> <li>Thermal runaway risk - fire hazard</li> <li>Higher degradation compared to some other energy storage technologies</li> </ul>	9	Yes
	Sodium-sulfur	<ul style="list-style-type: none"> <li>High temperature battery made of molten sodium and sulfur. Requires high temperature for operation (&gt; 300 C)</li> <li>Ceramic electrolyte used as a solid-state ion conductor</li> </ul>	<ul style="list-style-type: none"> <li>Molten metal can cause fire upon exposure to air</li> <li>Require high temps to operate</li> </ul>	9	No
Medium (Mid) Duration (8-24 hrs)	Compressed Air Energy Storage (CAES)	<ul style="list-style-type: none"> <li>No battery pack required</li> <li>Little to no metals used</li> <li>Caverns used for CAES systems - less of an eye-sore</li> </ul>	<ul style="list-style-type: none"> <li>Limited by availability of caverns and/or size requirements for above-ground storage vessels</li> <li>Diabatic CAES (TRL 9) heats stored air by combusting natural gas, process produces significant emissions</li> </ul>	6-9	No
	Pumped Hydro (PHES)	<ul style="list-style-type: none"> <li>Low operating costs and long life</li> <li>Water supply and flood control</li> <li>Limited CO<sup>2</sup> emissions</li> </ul>	<ul style="list-style-type: none"> <li>Limited by geography and water supply</li> <li>High start-up costs</li> </ul>	8-9	Yes
	Other Mechanical Storage	<ul style="list-style-type: none"> <li>Potential for large-scale energy storage with long lifespans</li> <li>Potential for longer storage durations</li> <li>Siting flexibility (with some options)</li> <li>Potential fast response time</li> </ul>	<ul style="list-style-type: none"> <li>Some techs requires specific infrastructure and/or siting requirements</li> <li>Challenges in maintaining efficiency over long periods</li> </ul>	6-8	No
	Flow Battery	<ul style="list-style-type: none"> <li>Power and energy are separated, enabling independent scaling. Energy storage can be increased simply by expanding the electrolyte capacity</li> <li>No significant fire hazards</li> </ul>	<ul style="list-style-type: none"> <li>Vanadium and Bromide based flow batteries are both corrosive and acidic</li> <li>Wholesale price of vanadium often fluctuate</li> </ul>	7-9	No
Long Duration (24+ hrs)	Metal Air Battery	<ul style="list-style-type: none"> <li>Low materials cost and supply chain issues due to use of earth-abundant materials</li> <li>No significant health or safety hazards</li> </ul>	<ul style="list-style-type: none"> <li>Very few technology providers at the moment</li> <li>Low roundtrip efficiency and high degradation</li> </ul>	7	No